

8/10

64

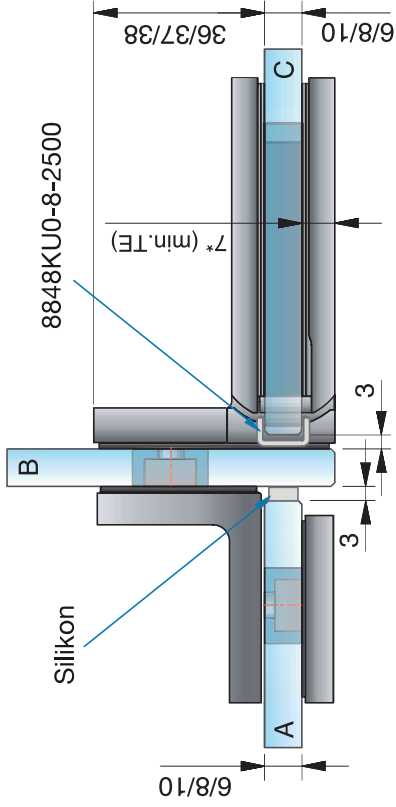

Silikon

8848KU0-8-2500

6/8/10

7* (min. TE)

3

3

36/37/38

6/8/10

*bei 8 mm

Glasbearbeitung
für 8 mm

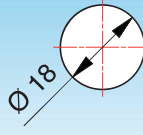
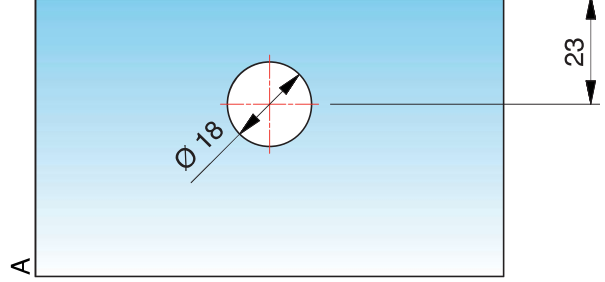

23

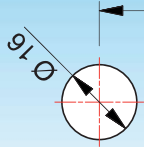
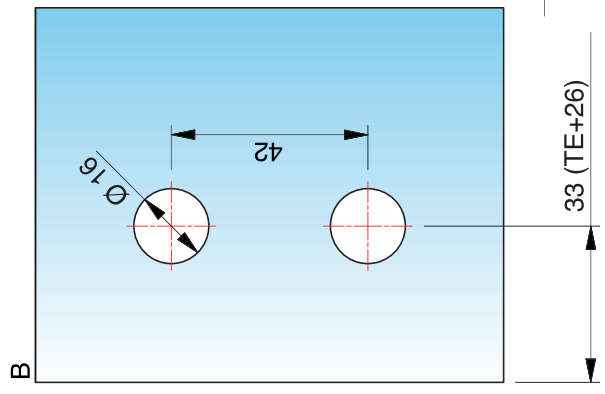

42

33 (TE+26)

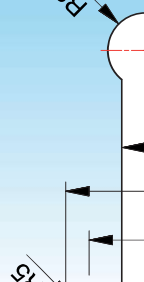
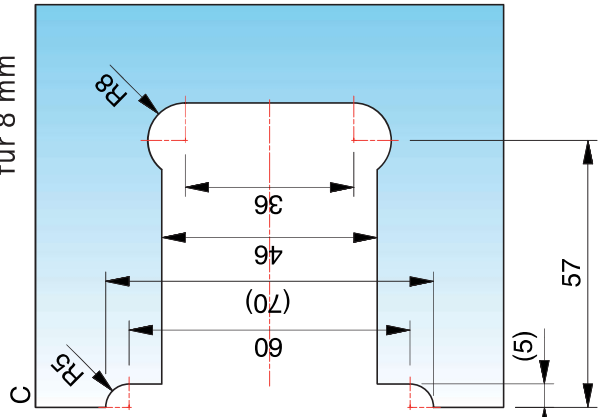

57

(5)

TE = Türeinstand